

Fan Bearing Selection

Introduction

This document will discuss the various types of bearings used in fan applications.

Fan applications demand quality bearings. Rolling element (or anti-friction) bearings are good selections for fan applications because they offer low friction and are reasonably priced. Twin City Fan Companies uses bearings with spherical roller, taper roller and ball shaped rolling elements. Each type has advantages and disadvantages which will be discussed later in this document.

Bearing Construction

While there are different types of rolling element bearings, they all have similar parts. Figure 1 is a cutaway view of a ball bearing unit showing the different components. The inner race is the part of the bearing attached to the fan shaft. The bore of the inner race mounts to the shaft, while the rolling elements roll on the outside diameter. The outer race surrounds the outside of the rolling elements. The rolling elements roll between the inner and outer races on paths machined into the races. The cage holds the rolling elements in place and keeps them from rubbing against each other.

Cutaway View of a Ball Bearing Unit

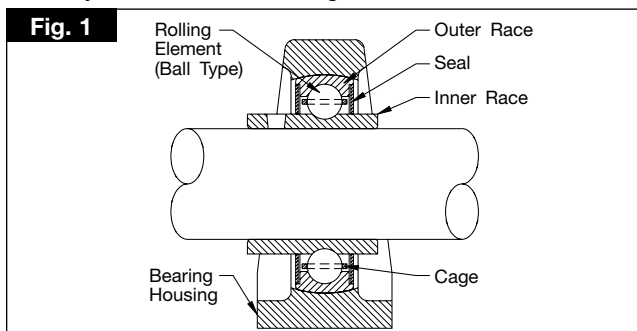

Cool, quiet, and low friction operation requires highly polished surfaces on the rolling elements and races. High load ratings and long bearing life make the use of high strength, high quality steels necessary. Race construction is hardened steel or sometimes alloy steel with just the bearing path hardened. Cage construction can be either plastic, brass, or steel.

The clearances between the rolling elements and the races are particularly important on fan bearings. While operating, the inner race warms up, expands, and reduces the clearance in the bearing. It is especially important to use bearings with extra internal clearance on high speed fans and fans handling high temperature air. Fan bearings are purchased with "air handling" or "C3" fits, which have slightly more internal clearance than "off-the-shelf" bearings.

Seals

Seals prevent foreign material from entering the bearing. Figure 2 shows the common types of seals used on fan bearings. The rubber lip seals shown on the ball bearing are the simplest type, but since they seal by having contact with the inner race, heat due to friction results in speed limitations. Labyrinth seals are frequently used when higher speeds are needed.

Common Types of Fan Bearing Seals

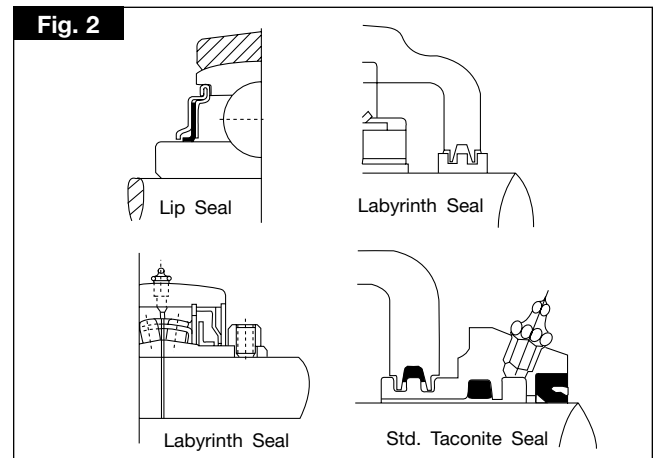

Dirty environments require especially good seals. Split pillow block spherical roller bearings can be fitted with a very effective seal known in the industry as a "taconite" seal. These seals were developed to withstand the very dirty and abrasive environment of taconite processing. While these seals do an excellent job of sealing, they seal by contact and have speed limitations. For example, a $2^{15}/16$ " bearing that has a speed limit of 3000 RPM with labyrinth seals has a speed limit of only 1050 RPM with taconite seals.

Inserts & Housings

The bearing insert is an assembly consisting of the inner race, rolling elements, cage(s), outer race, and on some bearings the seals.

Bearing inserts mount in a bearing housing. Cast iron or cast steel housings are superior to pressed steel housings because they provide higher strength and greater stiffness. Most of the bearings that Twin City Fan Companies uses have pillow block housings. This type of housing provides a means for supporting a shaft parallel to the mounting surface. Some small fans use bearings that mount in four bolt flange housings. This housing provides a means for supporting a shaft when the shaft is perpendicular to the mounting surface.

Bearing Types

One way to classify bearings is by the type of rolling element they have.

Ball bearings are the most economical bearing type. They also have a high speed capability, which make them attractive for fan applications. The races of these bearings are a deep groove type, which give them good thrust load capabilities. This feature, along with the contact seals that most ball bearings have, make them a good choice for small to medium size fans with shafts in the vertical position.

Ball Bearings. The bearing in Figure 3 is a typical ball bearing in a pillow block housing. It has been cut away in order to show the components. The outside surface of the outer race and the mating surface inside the bearing housing are spherically shaped. This feature allows the bearing to rotate in the housing, similar to a ball and socket joint. This way the two fan bearings can align themselves if the mounting surface is not perfectly flat.

Most of the ball bearing units that Twin City Fan Companies uses attach to the shaft using setscrews. The inner race is extra long and drilled and tapped for two setscrews that bite into the shaft.

Twin City Fan Companies uses two grades of ball bearings: standard duty units such as SKF SY, Dodge SCAH Browning VPS200, and Sealmaster NP; and medium duty units such as SKF SYM, Dodge SCMAH Browning VPS 300, and Sealmaster MP and MPD.

The relatively high thrust capacity of ball bearings allows the use of two fixed bearings on most fan applications. In cases where there is the potential for shaft expansion such as high temperature fans (airstream over 300°F), it is necessary to use expansion bearings. These bearings, such as the Sealmaster EMP series, allow the bearing insert to move axially in the bearing housing. An expansion bearing must always be used with a fixed bearing since expansion bearings cannot carry any axial load.

Two-Bearing Housing. Two new types of bearings have advantages in high speed and low vibration fan applications. The two-bearing housing shown in Figure 4 consists of two ball bearings mounted in a common pillow

housing. The bearings are press fitted to the shaft which is the best way to mount bearings. This ensures that the center of the shaft is lined up with the center of the bearing and that the bearing is securely connected to the shaft. Mounting them in a common housing ensures alignment of the two bearings. These features allow bearings mounted in a two-bearing housing to operate at higher speeds than separate setscrew mounted bearings.

Adapter Mounted Bearings. Adapter mounted ball bearings as shown in Figure 5 mount to the shaft using a tapered adapter. A locknut on one side of the bearing pushes the bearing up the tapered adapter until the bearing is securely attached to the shaft. This type of mounting also ensures that the center of the shaft is lined up with the center of the bearing. Like with the two-bearing housing, this type of mounting allows higher speed limits than setscrew mounted bearings. The balls on these bearings are also larger than conventional bearings which allows higher loads.

Spherical Roller Bearings. For fan applications where ball bearings do not give adequate life, spherical roller bearings are used. These bearings have two rows of rolling elements in a common outer race and a common inner race. The spherically shaped rollers and inside surface of the outer race give these bearings the ability to handle angular misalignment and extra load capacity.

The extra load capacity comes from the spherically shaped load carrying surface. A ball shaped rolling element has point contact with the bearing races. A spherical roller bearing has line contact with the races. How much stress the steel used to make the rolling elements can take limits how much load the bearings can handle. With spherical rollers the load is spread out over a larger area, which lowers the stress and allows them to handle higher loads.

Spherical roller bearings do not handle pure thrust loads well. Under this type of condition the rollers on one side of the bearing carry the load, while rollers on the other side carry none of the load. Spherical roller bearings need a minimum load for the rollers to roll in the races properly; otherwise they skid and twist against the races and cages, which causes heat and premature failure. To prevent this problem, spherical roller bearings

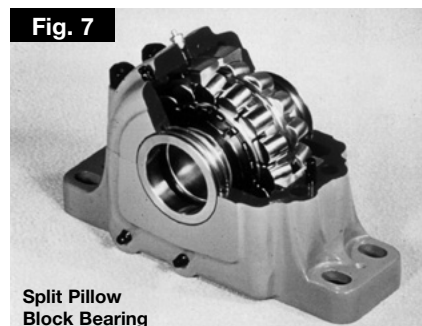
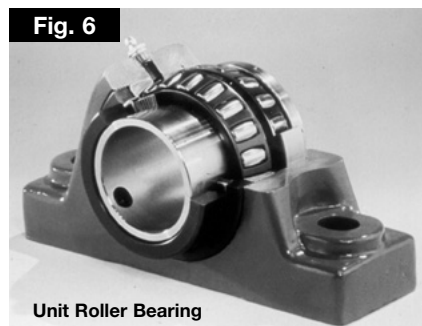
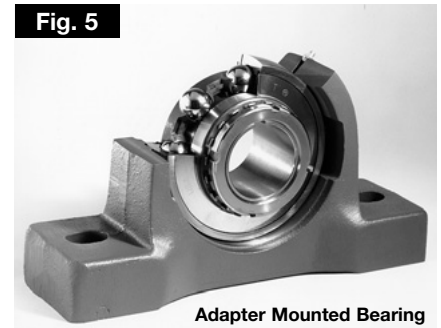
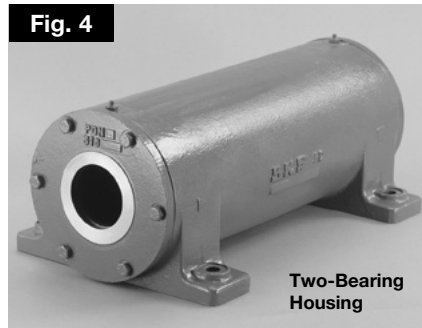
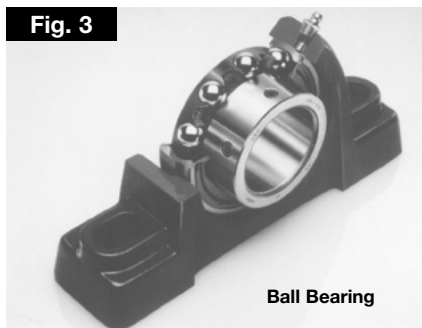

are used in fixed and expansion (sometimes called “float”) combinations. Twin City Fan Companies uses a fixed bearing for the bearing that is closest to the drive and an expansion bearing for the other one. This arrangement guarantees there is adequate radial load in order to carry the thrust load and guarantees that the rollers will roll properly.

Two types of housings are available with spherical roller bearings. Unit roller bearings, as shown in Figure 6, have a one-piece cast housing. Split pillow block bearings, as shown in Figure 7, have a two-piece housing.

Unit roller bearings such as SKF SYR, Dodge S2000, and Linkbelt 22400 series use a setscrew mounting on the shaft and have seals as an integral part of the bearing assembly. They are smaller in size than split pillow blocks, and the setscrew mounting works well on fans with bearing assemblies mounted in internal housings, such as centrifugal inline and some axial fans.

Split pillow block spherical roller bearings such as SKF SAF and Linkbelt 6800 series have higher load capacities than the unit rollers. The labyrinth seals normally used have high speed limits. The bearing insert mounts directly on the shaft by means of a tapered adapter held in place with a lock nut. This type of mounting centers the bearing on the shaft, unlike setscrew mounted bearings which tend to offset the shaft from the center of the bearing by a small amount. These features make this type of bearing suited for high speed, high horsepower, and high pressure fan applications.

Because split pillow block spherical roller bearings have the highest load rating there is a temptation to specify them because they are the “best.” This is not always a good idea. Often this leads to a bearing being too lightly loaded, which can be as bad as being too heavily loaded, as discussed previously. In addition it is not a good idea to select these bearings as “cap loaded,” when the load goes through the top of the pillow block. The pillow blocks are not designed to handle loads oriented this way. Another problem is using these bearings on fans with vertical shafts. In order to get the high speed limits, labyrinth seals are used. On vertical shafts these seals allow too much lubricant to leak.

Life Expectancy

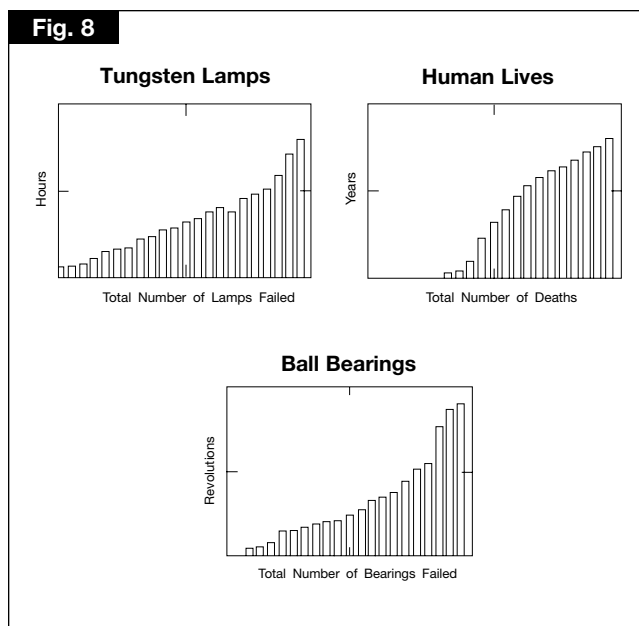

Bearing Life

Under laboratory conditions with controlled loads and lubrication, bearings fail due to fatigue. Rolling elements and bearing races eventually start to fail from the repetitive loading and unloading. In theory, all bearings have a finite life and will eventually fail. Figure 8 shows that as with light bulbs and humans, as time goes on the probability for the end of life increases. Just as statistical methods can estimate human life expectancy, they can estimate bearing fatigue life.

The Anti-Friction Bearing Manufacturers Association (AFBMA), and the International Organization for Standardization (ISO) specify the method used in determining the expected life of a bearing. They define L-10 life as the number of hours 90% of a group of identical and identically loaded bearings will survive without failing. This term, also called “minimum” life, is a function of bearing type, load, and speed. Note that the number of hours (or revolutions) and the load conditions must be specified. For example, saying that a bearing must have an L-10 life does not mean anything, while specifying an L-10 life of 40,000 hours at a fan’s maximum design condition is distinct.

Table 1. Typical L-10 Lives

CLASS OF MACHINE	L-10 LIFE (HRS.)
Household machines, agricultural machines, instruments.	300 - 3000
Machines used for short periods or intermittently: Electric hand tools, passenger cars, construction machines.	3000 - 8000
Machines requiring reliability during short periods or intermittently: Elevators, cranes for packaged goods or slings of drums, bales, etc.	8000 - 12000
Machines for use 8 hrs./day but not always fully utilized: Gear drives for general purposes, electric motors for industrial use, rotary crushers.	10000 - 25000
Machines used 8 hrs./day and fully utilized: Machine tools, woodworking machines, machines for the engineering industry, cranes for bulk materials, fans, conveyor belts, printing equipment, separators and centrifuges.	20000 - 30000
Machines for continuous use 24 hrs./day: Rolling mill gear units, medium sized electrical machinery, compressors, mine hoists, pumps, textile machinery.	40000 - 50000
Water works machinery, rotary furnaces, cable stranding machines, printing presses, propulsion machinery for ocean going vessels.	60000 - 100000
Machines requiring extreme reliability for use 24 hrs./day: Large electric machinery, power station machinery, mine pumps, mine ventilator fans, tunnel shaft bearings for ocean-going vessels, paper making machinery.	≈ 100000

Occasionally, the term “average life” or L-50 is used. This is the number of hours that 50% of a group of identical, and identically loaded bearings would survive. It is calculated by multiplying the L-10 life by five. For example, a bearing with an L-10 life of 40,000 hours has an L-50 life of 200,000 hours.

Table 1 gives typical L-10 lives for various bearing applications. They range from 300 hours for noncritical intermittently used applications, to 100,000 hours for critical applications. Most Twin City Fan Companies products have bearings selected for L-10 lives of at least 40,000 hours at the design maximum speed and horsepower. Some axial products are selected for 20,000

hours L-10. See the product catalogs for the bearing life specifications.

Keep in mind that L-10 life is related to fatigue failure. From a practical standpoint, specifying an L-10 life over 200,000 hours offers very little advantage since other factors such as relubrication frequency, lubricant breakdown, or lack of cleanliness will cause failure before fatigue does. In fact, specifying an L-10 that is too high can result in a bearing with not enough load. With too little load, rolling elements can skid against the races instead of rolling properly. In time, this will lead to a bearing failure.

Frequently, factors other than fatigue have the most influence on bearing life. As an example, a bearing on a fan operating in a hot, moist, and extremely dirty environment with an L-10 life of 40,000 hours is likely to have its life limited by seal failure, lubricant breakdown, rust, or dirty lubricant. This may occur before 40,000 hours.

The equation for L-10 life in hours is:

$$L-10 = \frac{16666}{n} * \left(\frac{C}{P}\right)^p$$

In this equation, *n* is the speed in RPM, *C* is the dynamic load rating, *P* is the equivalent radial load, and *p* is 3 for ball bearings and 10/3 for spherical roller bearings.

The dynamic load rating depends on the type and size of the bearing. For example, a ball bearing with a 1⁷/₁₆" bore has a lower load rating than a spherical roller bearing of the same size. Similarly, a ball bearing with a 1¹⁵/₁₆" bore has a higher load rating than one with a 1⁷/₁₆" bore.

The equivalent radial load takes into account the radial and axial load on the bearing. The radial load is perpendicular to the shaft, while the axial, or thrust load, is parallel to the shaft. Multiplying the radial and axial loads by special factors and adding them together determines the equivalent load.

Figure 9 compares the L-10 lives of four types of bearings at a given load and speed. Notice how drastically the life increases when going from a ball bearing to a roller bearing.

Fig. 9	
2¹⁵/₁₆" Diameter Shaft	
P = 500 lb.	
n = 3500 RPM	
Bearing Type	L-10 Life (hrs.)
Standard Duty Ball	28,424
Heavy Duty Ball	47,524
Unit Roller	5,204,301
Split Pillow Block Roller	6,478,400

This document describes the various types of bearings used in fan applications. FE-1300 describes how bearing installation and maintenance affects the useful life of bearings.

